



**duradecor**

modernmaven | Rigid Core  
**Product Guide**





# **duradecor**

## **Table of Contents**

<b>Technical Data Sheet</b>	<b>3</b>
<b>General Information</b>	<b>4</b>
<b>Recommended Tool List</b>	<b>5</b>
<b>Installation Instructions</b>	<b>6</b>
<b>Installation Images</b>	<b>9</b>
<b>Flooring Installation Images</b>	<b>10</b>
<b>Maintenance Instructions</b>	<b>11</b>
<b>Product Warranty</b>	<b>12</b>

### General Specifications

Overall Product Thickness:	<b>5.2 mm</b>
Underlayment Thickness:	<b>1.0mm IXPE Foam</b>
Wear Layer Thickness:	<b>20 mils (0.5 mm)</b>
Product Type:	<b>Rigid Core Floating Floor</b>
Product Dimensions:	<b>7" x 47.75"</b>
Finish:	<b>Scratch-Resistant Polyurethane</b>
Residential Warranty:	<b>Lifetime</b>
Commercial Warranty:	<b>10 Years</b>
Carton Quantity:	<b>10 Pieces (23.21 sq. ft.)</b>
Carton Weight:	<b>40.93 lbs.</b>

### Technical Specifications

ASTM F3261 - Rigid Core Specification:	<b>Class I, Type B, Grade 1, Backing Class B</b>
ISO 24337 - Size & Squareness:	<b>Passes, ± 1.5 mm size, ± 0.25 mm squareness</b>
ASTM F387 - Thickness of Flooring w/ Foam Layer:	<b>Passes, ± 0.2 mm</b>
ASTM F410 - Wear Layer Thickness:	<b>Passes, ≥ 0.5 mm</b>
ISO 24337 - Flatness:	<b>Passes, ± 0.2 mm width, &lt; 0.2% length</b>
ISO 24337 - Joint Opening:	<b>Passes, ≤ 0.2 mm</b>
ISO 24337 - Joint Ledging:	<b>Passes, ≤ 0.15 mm</b>
ASTM F1914 - Residual Indentation:	<b>Passes, ≤ 0.18 mm</b>
ASTM F1914 - Surface Integrity:	<b>Passes, no puncture</b>
ISO 23999 - Dimensional Stability:	<b>Passes, ≤ 0.2% / lin. ft.</b>
ISO 23999 - Curl:	<b>Passes, ≤ 2 mm</b>
ASTM F925 - Chemical Resistance:	<b>Passes ASTM F3621 requirements</b>
ASTM F1514 - Resistance to Heat:	<b>Passes, &lt; ΔE 8</b>
ASTM F1515 - Resistance to Light:	<b>Passes, &lt; ΔE 8</b>
ASTM F970 - Static Load:	<b>Passes, ≤ 0.13 mm indent, 250 lbs.</b>
ASTM E648 (NFPA 253) - Critical Radiant Flux:	<b>Class 1, &gt; 0.45 W/cm<sup>2</sup></b>
ASTM E662 (NFPA 258) - Smoke Density:	<b>Passes, &lt; 450</b>
ASTM D2047 / UL 410 - Slip Resistance:	<b>&gt; 0.5 SCOF (no ramps)</b>
ASTM E492 / E989 - Impact Insulation Class:	<b>IIC 57 (6 in. Concrete)</b>
ASTM E90 / E413 - Sound Transmission Class:	<b>STC 50 (6 in. Concrete)</b>
ASTM E2179 - Delta Impact Insulation Class:	<b>ΔIIC 25 (6 in. Concrete)</b>

**Disclaimer:** These test results were independently tested, using material from standard production, in accordance with product-specific standard test methods. Physical and performance testing may vary, within tolerances, depending on the testing apparatus and/or production lot used. Be sure to use the most recently published versions of all reference documents, specifications and test methods. To purchase the most recent version of the above mentioned ASTM and ISO standards, please visit [www.astm.org](http://www.astm.org). or [www.iso.org](http://www.iso.org), respectively. Test reports are available upon request.

**Limitations**

This flooring has a Solid Polymeric Core (SPC) and is designed to be installed indoors only as a “floating floor” for residential applications. The optimal operating temperature is between 40°F to 90°F (4°C to 32°C). Avoid prolonged exposure to direct sunlight or other heat sources where temperatures will exceed 90°F (32°C), as damage may occur. This product is not suitable for heavy rolling loads. Rolling chairs with soft or W-type casters and a maximum rolling weight of 250 lbs. are acceptable, provided that a polycarbonate chair mat is used to protect the flooring in rolling chair areas. Do not secure flooring or furniture to the subfloor with mechanical fasteners or adhesives. Do not install cabinets, kitchen islands, or other non-movable furniture on top of this floor covering. If required or concerned, immediately contact the technical department at [customercare@duradecor.com](mailto:customercare@duradecor.com) or 1 - (855) 700 - 5666 for assistance. Copies of ASTM documents are available for purchase at [www.astm.org](http://www.astm.org).

**Warning**

All local, state, and federal regulations must be followed; this includes the removal of in-place asbestos (floor covering and adhesive) and any lead-containing material. The Occupational Safety and Health Administration (OSHA) has exposure limits for people exposed to respirable crystalline silica; this requirement must be followed. Do not use solvent or citrus-based adhesive removers. When appropriate, follow the Resilient Floor Covering Institute’s (RFCI) Recommended Work Practice for Removal of Existing Floor Covering and Adhesive. Always wear safety glasses and use respiratory protection or other safeguards to avoid inhaling any dust. The label, installation, and maintenance instructions along with the technical data sheet, limited warranty and any appropriate Safety Data Sheet (SDS) of all products must be read, understood, and followed before installation commences. If the substrate or subfloor fails for any reason, then the floor covering limited warranty is void.

**Site Conditions & Storage**

The prepared installation area must be fully enclosed and weather tight. During the installation, any direct sunlight should be blocked using blinds, drapes or other protection. The ambient temperature during installation must be > 60°F (16°C), with a recommended maximum of 80°F (27°C). Note: When installing at temperatures > 80°F (27°C), the size of an expansion gap will increase when the floor covering is cooled.

**Documentation**

Record and file the measured and observed site conditions and test results, including all photographs and corrective measures. Maintaining this documentation, along with the original invoice and any labor receipts

throughout the warranty period, is recommended, as this will be required in the unlikely event of a claim.

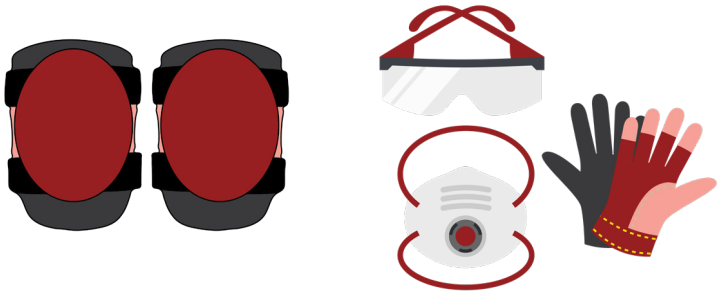

- Knee Pads
- Safety Glasses
- Cut-Resistant Safety Gloves
- Dust Mask

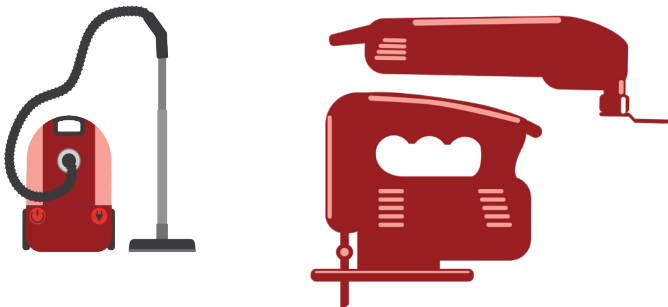

- HEPA-Filtered Vacuum
- Oscillating Multi-Tool or Hand Saw (for door jambs)
- Jigsaw with Carbide Blades (for complicated cuts)

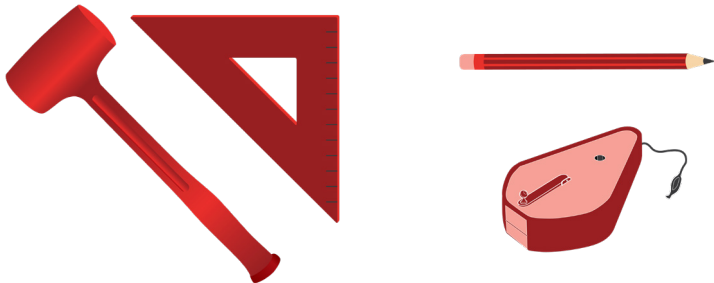

- 2 lb. (~32 oz.) Dead Blow Hammer (preferred) or Rubber Mallet
- Speed Square
- Pencil
- Chalk Line

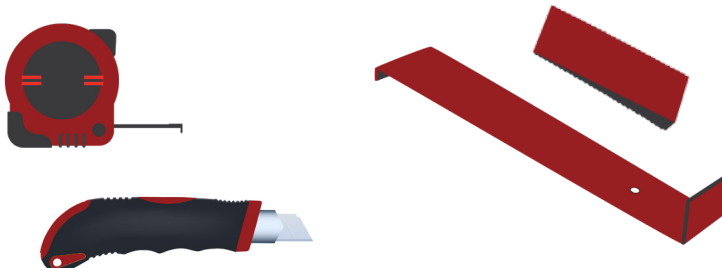

- Tape Measure
- Utility Knife with Blades
- Wedge Spacers
- Pull Bar



- 6-foot and 1-foot Straight Edge or Level

## 1. Substrate Preparation

### Flatness

Check all substrates for flatness prior to installation. The maximum acceptable tolerance is < 1/8-in. gap (2 x US quarters) over 6-ft. and ≤ 1/16-in. gap (1 x US quarter) over 1-ft. Make any necessary adjustments to the substrate before installation. Dormant cracks, saw cut joints and grout lines < 1/8-in. wide or deep are acceptable – all others must be cleaned of all dirt and debris, then filled using a suitable commercial grade patching or repair compound, following the product instructions.

### Concrete Substrates & Concrete Moisture

All concrete must be free of contaminants and structurally sound. If required, smooth the surface using a suitable, moisture-resistant commercial grade leveling or patching compound, following the product instructions. Do not install if hydrostatic pressure is visible, present or suspected. If a chemical adhesive remover has been used, contact the technical department.

For all on and below grade concrete slabs, test the surface to confirm it is absorbent (porous), following the ASTM F3191 Standard Practice for Field Determination of Substrate Water Absorption (Porosity) for Substrates to Receive Resilient Flooring. The water droplets placed on the substrate must be absorbed for it to be considered absorbent. If required, the concrete can be made porous by mechanical methods, such as diamond grinding, a DiamaBrush buffer attachment, shotblasting or similar.

If the substrate cannot be made porous and will not have a topical moisture mitigation system installed, install a ≥ 6-mil thick polyethylene (PE) sheet, which is available at most home improvement stores. Use sheeting that is ≤ 10-ft. wide to prevent wrinkles and folds. Sheeting must be installed over the entire area and extend at least 2-in. up the walls. All seams must be overlapped and sealed according to the product instructions.

### Wood Substrates

All wooden subfloors and substrates must be dry and in compliance with the moisture content percent (MC-%) for your region. Regional values are freely available by searching “moisture map of wood” images. Test using a non-destructive electronic moisture meter, following the product instructions.

The subfloor must comply with local building codes, have at least 18-in. of well-ventilated air space below and have a suitable vapor retarder to isolate the subfloor from ground cover and outdoor conditions. Wood subfloors must have a total thickness of at least 1-in. Sleepers must not make direct contact with concrete or earth. If necessary, install an underlayment grade plywood with a minimum thickness of 1/4-in. on the surface. The underlayment must be installed

in the opposite direction to the subfloor, following ASTM F1482 Standard Practice for Installation and Preparation of Panel Type Underlayments to Receive Resilient Flooring.

Note: plywood is a water-sensitive subfloor that may become damaged or deformed by topical liquids. To protect wood subfloors from topical water exposure, follow the Wet Area Guidelines below.

### Radiant Heating Substrates

When installing floor covering over a substrate that contains a radiant heating system, ensure the radiant heat does not directly contact the floor covering and is set at the correct “in-service” temperature for 48-hours prior, during and after the installation. The radiant heat may be gradually increased or decreased to maintain the correct “in-service” site conditions.

Note: Ensure the temperature of the radiant heating system does not exceed 85°F (29°C).

### Additional Acoustic Underlayments

Additional acoustic underlayments are not recommended or required. However, should one be used, ensure a polycarbonate chair mat is used in all rolling chair areas. Do not use additional acoustic underlayments in any commercial areas.

### Unsuitable Substrates

These include but are not limited to: any floating or loose floor coverings, hardwood, carpet, cushion vinyl, rubber, cork, foam, asphalt tile, any additional acoustic underlayment, any substrate with visible mold, mildew, or fungi and any substrate in wet areas, such as inside showers and saunas. Do not install directly over any adhesive or adhesive residue of any kind. Do not install directly over radiant heated substrate or in recreation vehicles, campers or boats.

Note: Existing hardwood floor coverings will swell when exposed to moisture: vinyl floor covering may restrict the movement of moisture in hardwood, which may result in flooring failure, especially when installed on or below grade. Some hardwood floor coverings may also discolor vinyl floor covering, which is excluded from warranty coverage. By electing to install over any existing floor covering releases the manufacturer from any responsibility regarding the suitability and continued performance of that product, including any resulting effect on the new floor covering, such as indentations and damaged locking mechanisms.

### Other Subfloors/Substrates

These may be acceptable. However, they must be smooth, flat and remain dry, without contaminants and be structurally sound.

### Wet Area Guidelines

Some subfloors and substrates, such as plywood, may be



sensitive to and damaged or deformed by topical liquids, such as water, pet urine and spills. While ModernMaven Rigid Core Flooring is a waterproof product, water-sensitive subfloors may require additional protection to prevent water exposure. When installing floor covering in wet areas, ensure that bathmats or similar are used where appropriate to decrease the amount of water that can collect on the surface. Any and all spills should be cleaned up immediately after discovering them and within 8 hours. Subfloor flatness is critical to preventing water migration through seams that may flex or peak due to foot traffic and subfloor deflection - be sure to check flatness and make all necessary adjustments prior to installing.

Water-sensitive substrate must have a  $\geq 6$ -mil thick polyethylene (PE) sheet (available at Hardware stores) installed over the entire area and extend at least 2-in. up the walls. All seams must be overlapped and taped according to the product instructions. In addition, the area must be separated from all other rooms using a suitable water-resistant t-molding. Following flooring installation, the plastic sheet must be trimmed flush with the surface of the subfloor. Prior to installing wall-base or molding, the required perimeter expansion gap must be filled with a 100% silicone caulk, including the wet area side of all t-moldings. Additionally, all door jambs, plumbing and vertical surfaces that won't have wall-base or molding installed must be sealed with 100% silicone caulk. Once the entire perimeter has been filled or sealed, water-resistant wall-base, moldings or other accessories may be installed. Apply a bead of silicone caulk to the parts of the wall-base or moldings that will make contact with the surface of the flooring. Ensure all wall base and moldings are attached to the subfloor, wall or wall-base without compression, to allow movement and cleanup any remaining silicone immediately. Do not anchor wall-base or moldings into or through the floor covering.

## 2. Expansion Gap

If the length or width of the installation area is  $\leq 50$ -ft., an expansion gap of at least 1/4-in. must be created around the entire perimeter. If the overall length or width is between 50 - 85-ft., then the gap must be increased to 1/2-in. around the entire perimeter. A maximum of 85-ft. in length or width must not be exceeded. If required, use a suitable trim molding covering the edges by 1/8-in. and allowing a 1/2-in. expansion gap.

For three-season rooms, a gap of at least 1/2-in. around the entire perimeter is required. In addition, the area must be separated from all other rooms using a suitable trim molding. The maximum of 30-ft. in length or width must not be exceeded.

Note: Areas with very heavy furniture  $\geq 800$ -lb. (363-kg) must be isolated from the rest of the installation with a compatible t-molding and have  $\geq 1/2$ -in. expansion gap.

## 3. Floor Installation Instructions

### General Installation Preparation

It is recommended that all wall-base be removed before flooring installation. Alternately, a quarter round molding that covers both the required expansion gap and at least 1/8-in. of the floor covering (attached to the wall or wall-base only) may be installed. Undercut all wooden door jambs and the first inch of any remaining wall-base (which will be covered with molding) with an Oscillating Multi-Tool or hand saw - the height must be the thickness of the floor covering plus 1/64-in., which allows the floor covering to expand and contract freely, out of sight, with temperature fluctuations (see figure 1). Steel door jambs should be pattern-scribed, leaving the required expansion gap. Use a color-coordinated 100% silicone to fill the void. Clean the entire area to be installed using a HEPA-filtered vacuum.

Before beginning, check and make sure the lot numbers on the packaging match and mix the floor covering from several boxes to ensure a random appearance. During the installation, inspect for visible defects, including any damage, gloss, color or shade variations, dirt and debris in the locking mechanism (remove using a soft brush), as installing it assumes full responsibility. If you have any concerns, do not install and immediately contact the technical department.

### Layout

Follow the design or drawings provided or agreed upon by the designer, architect, or end-user. The end joint layout for all planks should be random - make sure joints are not "stair stepped" (see figure 2). Failure to randomize end joints could weaken the integrity of the joint system, which may lead to failure. All planks must be at least 8-in. in length and all end seams must staggered by  $\geq 8$ -in. Tiles must be installed in a brick-bond pattern, offset by 1/2 or 1/3 of the plank.

### Cutting

To cut the floor covering, measure and mark the surface with a pencil, then carefully score the surface a few times on the mark using a sharp utility knife along the side of a speed square (see figure 3). Snap the plank downwards and complete by cutting the backing from underneath (see figure 4). For complicated cuts, such as door jambs, it is recommended to use a jigsaw with a carbide blade following the product safety instructions.

### Installation

Clean the entire area to be installed twice using a HEPA-filtered vacuum. Determine the best wall to start installation on - typically this would be the longest straight wall with a doorway (if present). Measure the width of the room and, allowing for two expansion gaps, calculate the width of your last row. If it is less than half the width of the floor covering, or if a balanced design is required, then reduce the width of the first row accordingly. Use a chalk-line to mark the outside edge of the first row on the substrate

(see figure 5). If needed, trim the first row (the side without the extended locking mechanism) to fit, accounting for the expansion gap.

### First Row (Slide)

At the left corner of the starting wall, position the first tile or plank flush with the walls. Use the side and end without the extended locking mechanism against the walls. Place wedge spacers between the floor covering and wall to maintain the required expansion gap around the entire perimeter (see figure 6). Before connecting the second piece, lay it flat on the substrate, adjacent to the first row and lined up with the end of the previous piece. Then, while keeping the joint perfectly in line, slide the second plank into the first, locking the mechanism together (see figure 7). Complete the first row using this method. If there is a doorway, measure, mark and cut the flooring to make sure the cut edge will be located underneath the door jamb and frame while maintaining the required expansion gap. A jigsaw should be used for complicated cuts like these. Keeping the installation straight is critical, so check the first row using a chalk line or similar and, as needed, adjust and reinforce the row by adding more wedge spacers. The acceptable straightness tolerance is within 1/16-in. for lengths over 20-ft. or 1/32 in. for lengths under 20-ft. Complete the following rows starting with a cut piece, such as a piece from a previous row. Install the side joints before the end joints as instructed under "Side Joints" and "End Joints".

### Side Joints (Angle-Angle)

Starting at the left corner, place the side without the extended locking mechanism into the side of the previously installed row at a ~ 25° angle (see figure 8). Make sure the joint is seated properly, then slide the plank or tile into position (see figure 9). The end joint must line up perfectly. Lay the tile or plank flat and complete the end joint.

### End-Joints (Drop-Lock or Fold-Down)

Always check the alignment of the end joint and adjust if necessary. Lock the joint into place by lightly tap along the high side, starting from the "T", using a 2-lb. (~ 32-oz.) soft faced dead blow hammer or rubber mallet (see figure 10). Keep the striking head flat with the floor covering and tap until perfectly flush. If the locking mechanism does not line up properly, then check and adjust the straightness as necessary.

### Additional Tips

Do not hit the locking mechanism directly with any hammer, tapping block or pull bar (except the last row) - doing so will damage the locking mechanism and may result in peaking, gapping or broken joints. If required, use a ~ 6-in. piece of scrap floor covering, seated in the locking mechanism, to lightly tap and close any joints.

If you need to install small cuts of floor covering that are < 3-in. in length or width, place a thin bead of liquid super-

glue on the previously installed locking mechanism just before installing. This will ensure the pieces remain locked together during use. Do not get the adhesive on the surface - coverage will be ~ 30 ft. per oz.

After the first five or six rows are completed, turn around and continue installing, working on top of the installed material. This will allow the side joints to be pulled together rather than pushed together, which will make the installation even easier.

If you need to disengage the end joints for any reason, first unlock the side joints by lifting the outside edge of the row to ~ 25° and disconnect the entire row. Make sure all pieces are lying flat and are properly engaged (tap to engage, if required), then simply slide them apart. If they are angled or pulled upwards, the joint will break.

### Completion

If used, plastic sheeting must be trimmed flush with the surface of the floor covering. If installed in a wet area, plastic sheeting must be trimmed flush with the subfloor. When installing in wet areas, ensure the expansion gap and all vertical surfaces are filled or sealed with a 100% silicone caulk and ensure all wall-base and moldings are water-resistant, following to the Wet Area Guidelines. Install all necessary wall-base and/or moldings and ensure they are anchored to the substrate, wall or wall-base without compression, to allow movement. Do not anchor wall-base or moldings into or through the floor covering. Save three or more extra pieces of material in the original packaging as attic stock for the lifetime of the floor. **In the unlikely event of a product issue, attic stock can play a crucial role in product identification, color matching, product claim verification and possible repairs.**

### Protection

If required, protect the clean floor covering from other trades or heavy loads using ½-in. plywood or similar and tape all seams. For light traffic, use Ram board or similar and tape all seams. For furniture, use only polyurethane, silicon or felt glides (replaced > 3-times a year), keeping them clean and grit-free - all glides should be ≥ 1-in.<sup>2</sup>, especially on heavy furniture. Use protective polycarbonate chair mats designed for resilient flooring underneath rolling chairs or soft "W-type" wheels. Use non-rubber-backed entrance matting at all outdoor entrances, as this will improve air quality and reduce maintenance. Do not drag heavy or sharp objects directly across the surface - use hard surface "sliders" (available at Hardware stores). For areas that may be subjected to standing water on the surface, such as bathrooms with a bath or shower, the perimeter of the installation must be properly sealed using a 100% silicon caulk to prevent water from getting beneath the flooring. To avoid excessive fading or discoloration from direct sunlight exposure, use appropriate window treatments, an effective UV/IR film or Low-E glass windows. Take photographs and have any required documentation signed and filed following



Figure 1: Preparation - Undercut Doorjamb

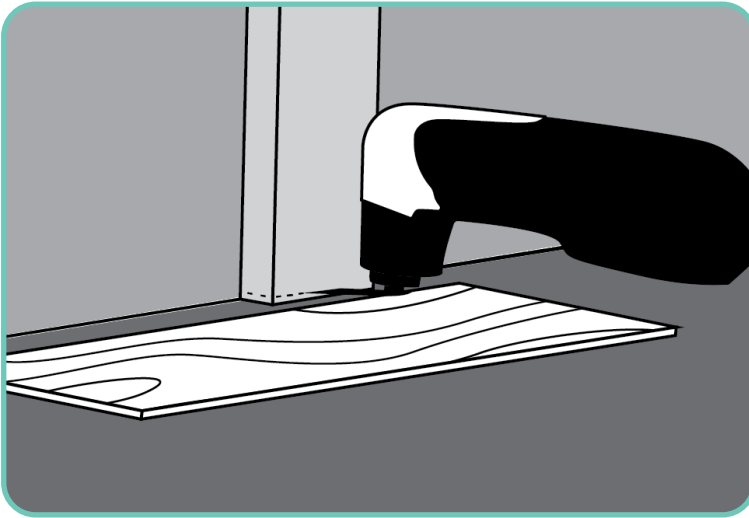

Figure 4: Cutting - Snap plank downward

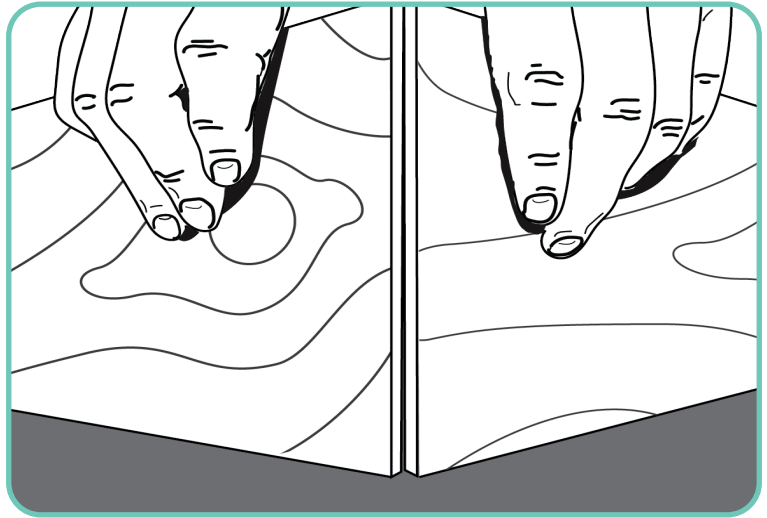

Figure 2: Layout - Stagger seams

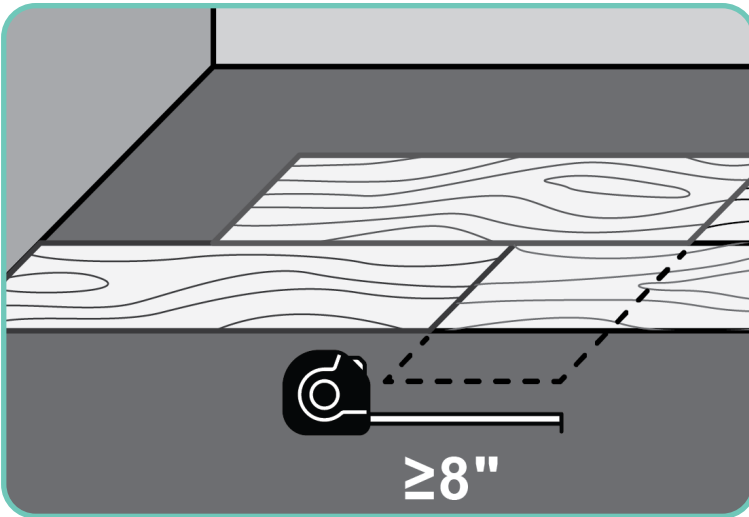

Figure 5: Installation - Mark the starting line

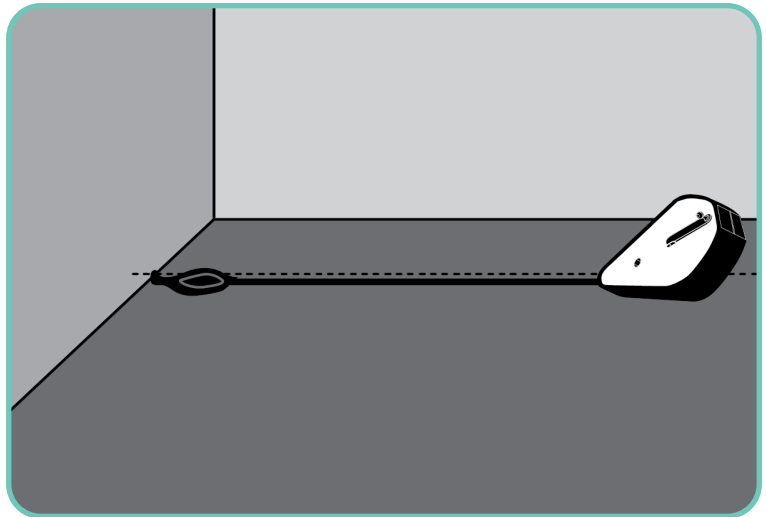

Figure 3: Cutting - Mark, score and cut

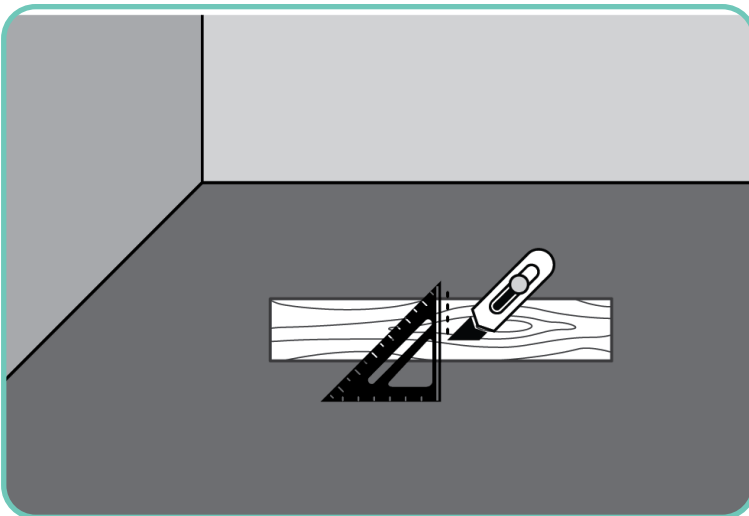

Figure 6: First Row - Place wedge spacers

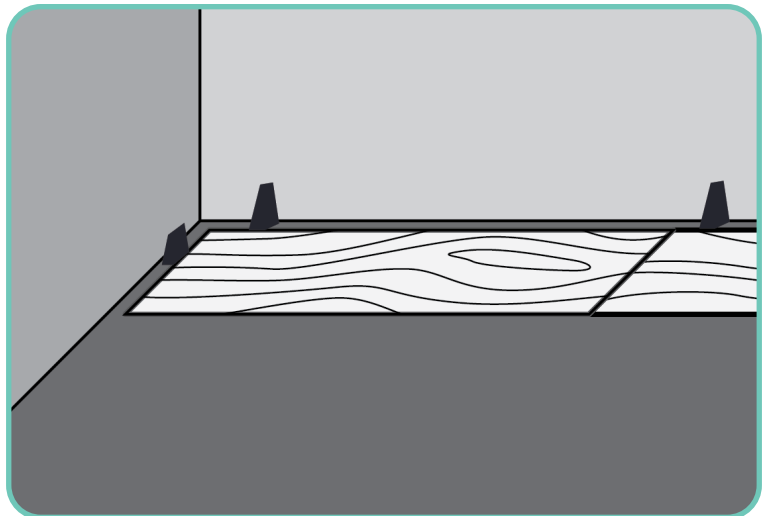

Figure 7: First Row - Slide planks together

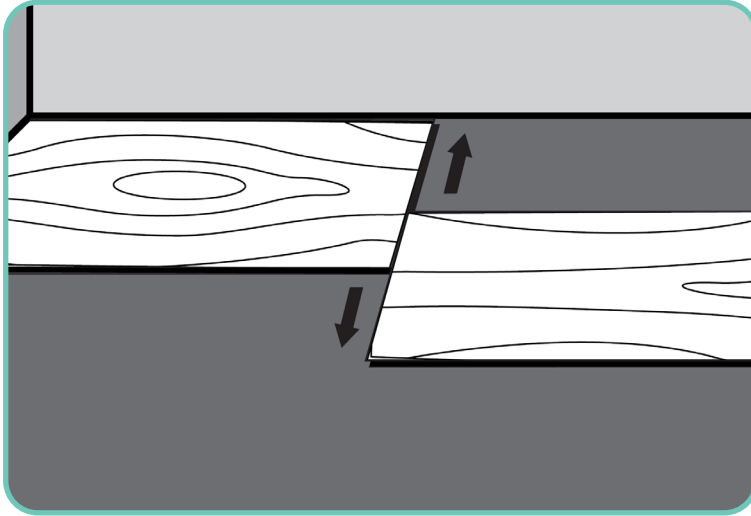

Figure 10: End Joints - Lock piece into place

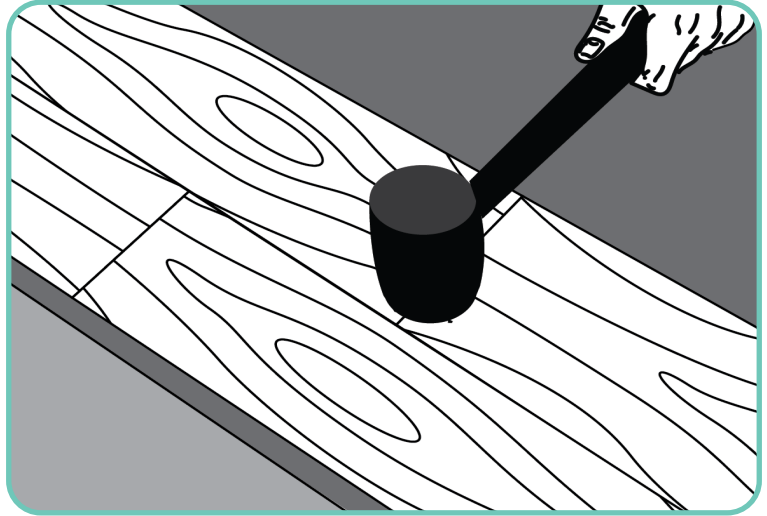

Figure 8: Side Joints - Install piece at 25° angle

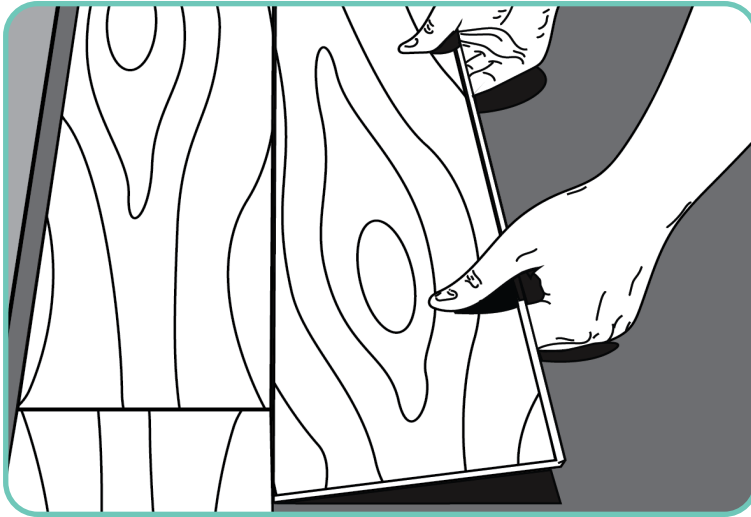
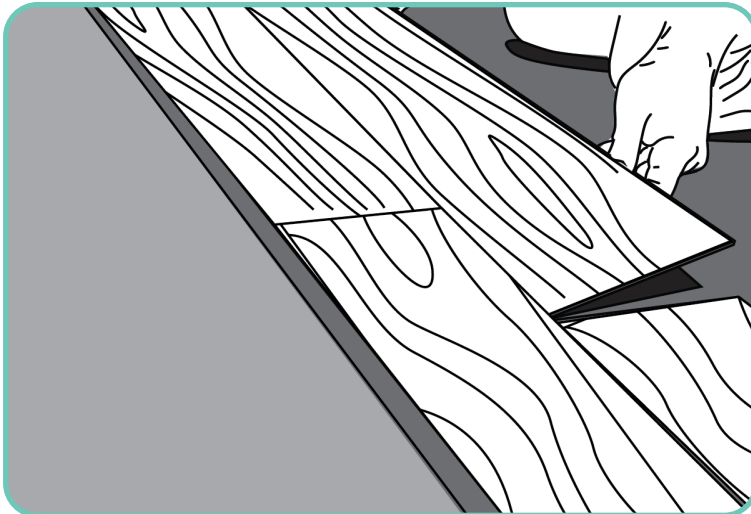

Figure 9: Side Joints - Align joint with previous



## 1. Precautions

Do not perform any maintenance procedures on wall installations for 72-hours. Remove all metal objects before conducting maintenance and prohibit foot traffic until the floor is dry. Do not use dust mops treated with oils or silicones, acetone, strong alkaline cleaning agents, multi-surface cleaners, vinegar/ammonia/ citrus oil solutions, scouring powder, strong solvents, or abrasive cleaning pads, as these can damage the flooring. Do not wet mop or allow cleaning solutions to puddle or pool on the surface of the material. The application of a floor-finish is not recommended and will change the maintenance protocol.

## 2. Regular Cleaning

Wipe, dust-mop or vacuum the material to remove any dirt or grit – do not use a vacuum with a beater bar. Damp-mop or wipe the material as often as required using a clean cloth, a flat microfiber mop or a spray mop or a flat microfiber spray mop. Use a pH neutral, film-free and streak-free cleaner concentrate (diluted with potable water), available at local hardware stores. Make sure to change the cloth or mop pad as often as required.

## 3. Deep Cleaning

Deep cleaning may be required when routine cleaning is not meeting expectations. Dust-mop or vacuum the floor to remove dirt or grit. Wet mop the entire floor using a suitable neutral pH cleaning solution. Allow the solution to dwell for ~ 5-10 minutes. Scrub the floor using a medium nylon broom or brush and remove the soiled solution using a wet vacuum. Rinse with clean water and allow it to dry before allowing foot traffic.

## 1. General Terms

DuraDecor ("Manufacturer") warrants that, when used properly and under normal operating conditions, the flooring products described in the Manufacturer's catalog as ModernMaven Rigid Core Flooring ("Product"), a 5.2mm thick rigid polymeric core floating floor covering that includes a 0.5mm (20-mil) wear layer, will conform with the published ASTM F3261 Standard Specification for Resilient Flooring in Modular Format with Rigid Polymeric Core, as detailed within the Manufacturer's published Product technical documents. This Limited Warranty is not transferable and only applies to the original end-user ("Customer") of the Product. This Limited Warranty does not apply to Product that has been sold or resold as "seconds", "mill-run", "off goods", "non-conforming", "as-is", "closeouts" or otherwise denoted as irregular, non-first or non-standard quality.

The Manufacturer's liability and Customer's exclusive remedy under this Limited Warranty is limited to the replacement or refund of the defective Product and, only if without visible and obvious (> 0.5-inch) defects will the Manufacturer include reasonable labor costs for the geographic region. This Limited Warranty does not include other costs associated with installation or removal of the defective Product or installation of the replacement Product including, but not limited to, lost time, furniture removal and/or overtime pay. Only one replacement floor or refund shall be made. A Customer who received a settlement may not make another claim - no additional replacement floors or refund will be supplied.

If the Manufacturer no longer provides the particular Product subject to this Limited Warranty, Manufacturer reserves the right to substitute another Product that Manufacturer deems to be comparable or superior in its place. Manufacturer's responsibility to replace defective Product under this Limited Warranty applies only to the affected area of Product so long as a suitable match (as determined and at the sole discretion of Manufacturer) can be supplied. Full replacement or replacement of a greater area than the affected area is at the sole discretion of Manufacturer. Manufacturer reserves the right to provide replacement materials directly to the Customer, or through a professional installation company of the Manufacturer's choice, to conduct repairs or replace materials in a manner suitable to the Manufacturer's interests.

This Limited Warranty is specific to the Product which shall be installed, used, maintained and cared for in accordance with the Product documentation, which may be obtained at [www.duradecor.com](http://www.duradecor.com) or are available upon request by contacting [customer@duradecor.com](mailto:customer@duradecor.com) or 1 - (855) 700 - 5666.

## 2. Warranty Terms & Provisions

**2.1. Manufacturing Defect Term:** The Product shall be free of manufacturing defects for a period of 1-year from the Customer date of purchase. All claims must be reported within thirty (30) days of discovery of the defect.

**2.2. Wear Warranty Term:** "The Product", when installed and maintained as detailed within the instructions, will not wear-through to the printed film layer under normal use for the period stated below:

<b>Residential Wear:</b>	Lifetime from date of purchase
<b>Light Commercial Wear:</b>	10-years from date of purchase

**2.3. Wear Warranty Provisions:** Stains from unapproved chemicals, fading, scratches, scuffs, and loss of gloss are considered normal use and are not covered under this warranty. The Manufacturer will supply new material of the same color, design, and grade, if available; if unavailable or discontinued, the Manufacturer reserves the right to supply similar floor covering. After corrective action is taken on an existing defect, Limited Warranty coverage will remain in effect for the remaining Wear Warranty Term of the original Limited Warranty.

Alternatively, at the Manufacturer's discretion, a refund of the original cost of the Product shall be used to settle all other valid claims according to the following pro-rated schedule:

<b>Residential Wear Coverage:</b>		<b>Light Commercial Wear Coverage:</b>	
≤ 1-year:	100%	≤ 1-years:	100%
≤ 5-years:	70%	≤ 3-years:	70%
≤ 10-years:	50%	≤ 5-years:	50%
≤ 20-years:	30%	≤ 7-years:	30%
> 20-years:	10%	≤ 10-years:	10%

**2.4. Labor Warranty Term & Provisions:** Labor costs shall not be reimbursed for all material installed with visible and obvious (> 0.5-inch) defects. Reasonable costs of professional labor for replacement must be submitted to and pre-approved by the Manufacturer. The percentage of labor costs that shall be reimbursed is according to the following pro-rated schedule:

Residential Labor Coverage:		Light Commercial Labor Coverage:	
≤ 1-year:	100%	≤ 1-years:	100%
≤ 5-years:	60%	≤ 3-years:	60%
≤ 10-years:	40%	≤ 5-years:	40%
≤ 20-years:	20%	≤ 7-years:	20%
> 20-years:	0%	> 7-years:	0%

**2.5. Waterproof Warranty:** The Product will not be materially impaired when exposed to wet or damp cleaning, surface spills and/or tracked in water for the length of the Wear Warranty. This does not include water emergencies.

**2.6. Petproof Warranty:** The Product surface coating provides scratch and stain resistance (such as feces, urine and/or vomit) from domestic household pets, such as cats and dogs, provided that pet claws are routinely cut and filed.

### 3. Warranty Exclusions

This Limited Warranty does not apply to nor cover nonconformities that are caused by, result from or arise in connection with any of the following conditions:

- **Non-Compliance with applicable Product requirements and technical data.** Any Product that has been subjected to site conditions, substrate conditions, installation methods, maintenance procedures and/or conditions of use that are not in strict conformity with the associated Technical Data Sheets, Installation Instructions, Maintenance Documents and any other relevant technical documents.
- **Non-Compliance with applicable industry guidelines.** Substrate preparation must be performed in accordance with all related ACI, ASTM, NWFA and RFCI guidelines.
- Installation of Product with unapproved installation materials, methods or tools, including but not limited to the recommended underlayment type, repair products and all accessories.
- Joint failure, cracking, warping, delamination, curling, or other phenomena caused by excessive heat sources, such as prolonged direct sunlight, radiators, self-cleaning ovens and high-heat equipment.
- Fading or discoloration of the surface due to excessive UV/IR exposure.
- Stains from tracked carpet dyes, fertilizers, coal, tar, driveway sealers, oil, permanent markers, or other such contaminates.
- Restriction of the natural expansion and contraction of

the flooring by any means.

- Substrate failure, movement or imperfections, including improper flatness or damage.
- Heavy static loads (>500 lbs. or > 250 PSI) and heavy point loads, such as foot traffic with stiletto heels, spikes or skates, dropped items, improper floor protectors and furniture feet/rests or floor protection and furniture feet/rests that do not make adequate flat contact with the floor covering.
- Heavy rolling loads (> 250 PSI), such as electric wheelchairs, hospital beds and rolling loads with metal wheels, hard H-type wheels or any other wheel types that do not make adequate flat contact with the floor covering.
- Damage, deformation or excessive wear caused by rolling chair traffic in areas that are not protected with a polycarbonate resilient flooring chair mat.
- All damage caused by mechanical issues, intentional abuse, misuse, negligence, structural damage, seismic activity, flooding, fires, and other emergencies, natural disasters or any circumstances beyond the reasonable control of the Manufacturer.
- All resulting health issues or property damage resulting from organic growth resulting from all types of water trapped beneath the floor covering and the latent organic material found within it, which may sponsor organic growth, such as mold, mildew, and fungi.
- Normal shade, color, gloss/sheen, or embossing texture variation, including variations between installed flooring and physical flooring samples or printed marketing materials.
- Excessive wear caused by improper maintenance, dirt, grit, and/or abrasive debris.
- Excessive moisture and alkalinity from the subfloor or substrate.
- Excessive topical water caused by broken or leaking plumbing, structural leaks, sink overflow, flooding, weather conditions and other water emergencies.
- Installations removed or replaced prior to inspection by an authorized DuraDecor representative.

### 4. Slip Resistance Warning

Walking is an enormously complex activity involving many muscles, bones and nerves, as well as kinesthetic sensory information. There are several significant factors that directly affect slip resistance properties, such as the type, texture and surface structure of floor covering, surface contaminates, type of shoe soles and the walker's weight, age, gait, fitness level, awareness, and vision. There are no published requirements or acceptable limits for Static Coefficient of Friction (SCOF) or Dynamic Coefficient



of Friction (DCOF) values within the resilient flooring industry, though there may be for other flooring types. While independent test results are available, that does not purport to address any safety concerns of slip resistance, the accuracy of all test methods, safety thresholds, or the measuring apparatus' (tribometers). This includes factors outside of the reasonable control of the Manufacturer, such as Product maintenance. No warranty for any slip resistance properties can be provided.

Note: Walking on any vinyl floor covering in socks or similar is not recommended, especially on stairs.

## 5. Warranty Claims

If, within the applicable warranty period identified in Article 2.1 and 2.2, the Customer discovers any problems or defects in the Product that may be covered by this Limited Warranty, the Customer must notify the distributor or the Manufacturer directly at 1-(855) 700 - 5666 or [customercare@duradecor.com](mailto:customercare@duradecor.com). All claims must include a completed claim form, along with any associated photos, invoices, pre-installation testing reports and all independent inspection reports conducted after problems or defects are observed or suspected.

All claims must include a completed claim form, along with any associated photos, invoices, pre-installation testing reports and all independent inspection reports conducted after problems or defects are observed or suspected. Attic stock may be required to verify the validity of product claims. Failure to provide attic stock could lead to product claims being declined, especially in the event that third-party products, such as but not limited to adhesives, accessories and underlayments, are used in conjunction with The Product.

If Manufacturer determines that the Product is covered by this Limited Warranty, then Manufacturer shall, at its sole option, replace the nonconforming Product or refund the appropriate percentage of the purchase price and labor cost paid for each defective Product for the affected area, per the associated pro-rated schedule. No warranty claims will be processed if received more than thirty (30) days after the applicable warranty period has ended. e shall have the right to examine the Product and the flooring, including the right to test the flooring and/or substrate at the installation site, with respect to any Product that is the subject of a warranty claim. Any removal of installed Product prior to such examination will void any and all warranties. Manufacturer may require additional testing or verification of any tests conducted or obtained by the Customer.

### 5.1. Warranty Disclaimer

**The warranties set forth herein are exclusive and in lieu of all other warranties or representations, express or implied, arising by law or custom, including the implied warranties of merchantability and fitness for a particular purpose. No agent, sales representative, dealer,**

**distributor, contractor, installer, architect or designer has the authority to increase or alter seller's obligations under this warranty. This Limited Warranty does give you specific legal rights; you may also have other rights, which may vary from state to state.**

## 6. Limitation of Liability

**The aggregate cumulative total liability of Manufacturer hereunder, whether for breach of warranty or contract, indemnification, tort (including negligence), or otherwise, shall not exceed the original purchase price of the nonconforming Product. Manufacturer assumes no liability for labor costs in the installation or replacement of any Product with visible and obvious (> 0.5-inch) defects. In no event shall Manufacturer be liable to Customer or any other person for loss of revenue, profit or any consequential, incidental, exemplary or punitive damages directly or indirectly arising from the use of the Product, from breach of any warranty or from any other cause, whether or not Manufacturer has been informed of the possibility of such damages.**